

PLUG-IN CONNECTOR



in partnership with



ALFAGOMMA

ALFAGOMMA PLUG-IN CONNECTOR

- TIME AND COST SAVING FOR ASSEMBLING AND INSTALLATION
- VERY COMPACT DESIGN, MINIMUM SPACE REQUIRED
- MAINTENANCE AND TESTING DOWN-TIME REDUCTION
- SAFETY STANDARDS AND RELIABILITY IMPROVEMENT

Alfagomma, in order to improve customer's effectiveness in hydraulic assembly installations, with the valuable collaboration of CMatic, has engineered and produced an innovative hydraulic connector for quick and smart connections: no wrench, no tightening; only a safe and easy "click". Plug-in Connector is the answer to reduced manifold surfaces and difficult assembly installations. Quick, Easy and Safe, Plug-in Connector has been thoroughly tested for 1 Million cycles at 5000 PSI (350 bar).

Thanks to the compact integrated socket, there's no need of additional hydraulic components or adapters. The operator does not even have to carry on-board hardware. Plug-in Connector reduces the exposure to under pressure machinery's components while increasing safety and speeding up assembly procedures. The Plug-in Connector is fully compatible with all hydraulic applications and represents an effective improvement of operations in connecting valves, filters, pumps, motors and other valuable components.

Hose Fittings

Straight

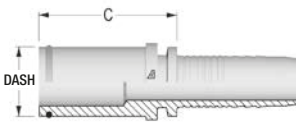

Code	Hose ID in	Hose ID mm	DASH	Plug-in DN DASH	C CUT-OFF mm
H1213Z10-040400	1/4	6,2	04	04	31,7
H1213Z10-060600	3/8	9,5	06	06	32,3
H1213Z10-080800	1/2	12,9	08	08	40,1
H1213Z10-121200	3/4	19	12	12	47,1

45° Elbow

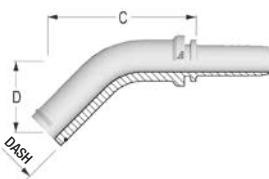

Code	Hose ID in	Hose ID mm	DASH	Plug-in DN DASH	D Drop mm	C CUT-OFF mm
H1213Z40-040400	1/4	6,2	04	04	24	47
H1213Z40-060600	3/8	9,5	06	06	28	55
H1213Z40-080800	1/2	12,9	08	08	32	62
H1213Z40-121200	3/4	19	12	12	44	83

90° Elbow

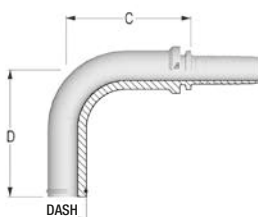

Code	Hose ID in	Hose ID mm	DASH	Plug in DN DASH	D Drop mm	C CUT-OFF mm
H1213Z90-040400	1/4	6,2	04	04	41,5	28,2
H1213Z90-060600	3/8	9,5	06	06	49,5	44,9
H1213Z90-080800	1/2	12,9	08	08	58,0	47,7
H1213Z90-121200	3/4	19	12	12	72,5	59,8

Plug-in Cartridge

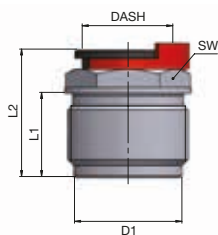

Code	Plug-in DN DASH	D1 Thread	L1 mm	L2 mm	CH mm
R1A3ZC152M-0418	04	M20x1	19	26,5	20
R1A3ZC152M-0622	06	M23x1	19	27,5	23
R1A3ZC152M-0825	08	M30x1,25	25	34,5	30
R1A3ZC152M-1233	12	M38x1,5	28	40	38

Plug-in Connector

BSPP Stud (ISO 1179-2)

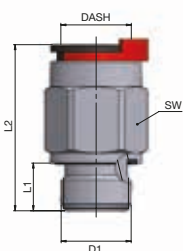

Code	Plug-in DN DASH	D1 Thread in-TPI	D1 Thread DASH	L1 mm	L2 mm	CH mm
R1A3ZF106I-0404	04	1/4-18	04	12	38,5	19
R1A3ZF106I-0606	06	3/8-18	06	12	39	22
R1A3ZF106I-0808	08	1/2-14	08	14	49	27
R1A3ZF106I-1212	12	3/4-14	12	16	58	35

SAE Oring Boss - UNF Stud (ISO 11926-3)

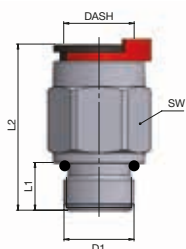

Code	Plug-in DN DASH	D1 Thread in-TPI	D1 Thread DASH	L1 mm	L2 mm	CH mm
R1A3ZF1305-0404	04	7/16-20	04	11	37,5	19
R1A3ZF1305-0606	06	9/16-18	06	12	39	22
R1A3ZF1305-0808	08	3/4-16	08	14	49	27
R1A3ZF1305-1212	12	1 1/16-12	12	18,5	60,5	35

Metric Stud (ISO 6149-3)

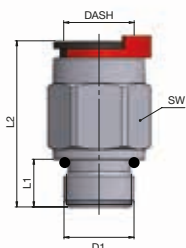

Code	Plug-in DN DASH	D1 Thread	D1 Thread DASH	L1 mm	L2 mm	CH mm
R1A3ZF1525-0414	04	M14x1,5	14	9	35,5	19
R1A3ZF1525-0616	06	M16x1,5	16	11	38	22
R1A3ZF1525-0818	08	M18x1,5	18	12,5	47,5	27
R1A3ZF1525-1222	12	M22x1,5	22	15	57	35

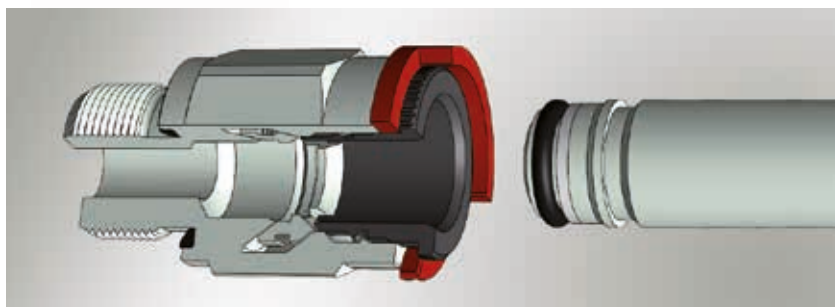



Head Office

Alfagomma SpA
Via Torri Bianche 1
20871 Vimercate (MB) Italy
marketing@alfagomma.com
www.alfagomma.com

PROVIDING EXCELLENCE AND RELIABILITY

ALFAGOMMA

Developing cutting-edge technology and innovative solutions. Supplying top quality products worldwide. These are the pillars on which **Alfagomma's** success has been built since 1956. Today, Alfagomma plays a leading role in the industrial and hydraulic rubber hoses segment, with 12 plants and a worldwide presence spread across 20 countries.

The Group has been providing top quality products for over 55 years and it has always been known for its excellent technical department: a strong commitment to quality and control design that is reflected in the Group's state-of-the-art product portfolio, which also include adapters and swivel connectors.

